

LEIGH RVA1 Router Vacuum Attachment

US PATENT No. 4,750,536

Instructions for assembly

- 1 Carton contents:**
- | | |
|------------------------|----------------|
| 1 90° Rod | 5 Hex Key |
| 2 Rod | 6 Collector |
| 3 Clamp Bracket | 7 Hose Adaptor |
| 4 Fence Rod Screws (4) | 8 Rod Adaptor |
| | 9 Instructions |

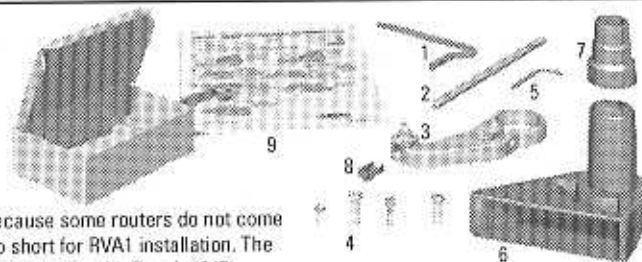

Note: We have supplied a few Fence Rod screws with your RVA1 because some routers do not come with fence rod screws, and some router fence rod knobs may be too short for RVA1 installation. The 12-24 and 1/4-20 work with Porter Cable; M6 with Festo and some DeWalt; M5 with Bosch 1617.

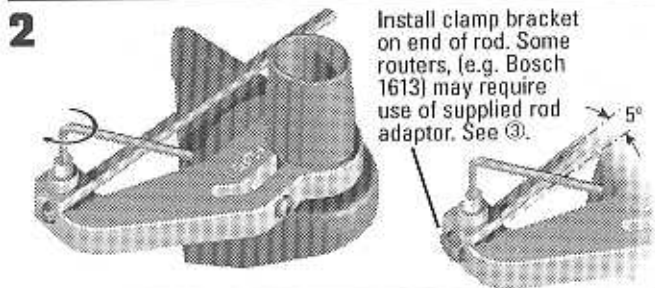

Install clamp bracket on end of rod. Some routers, (e.g. Bosch 1613) may require use of supplied rod adaptor. See ③.

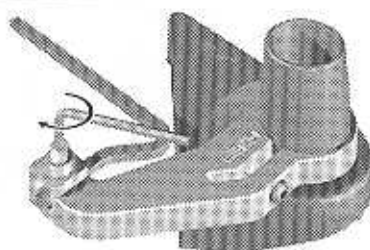

Use 90° rod for:
Festo 900, 1000;
Porter Cable
1001, 6931,
73561, 73571;
Bosch
1617, 1617EVS, 1618

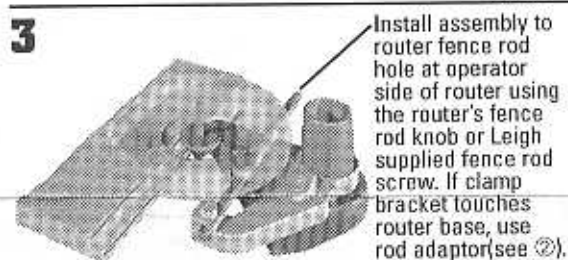

Install assembly to router fence rod hole at operator side of router using the router's fence rod knob or Leigh supplied fence rod screw. If clamp bracket touches router base, use rod adaptor (see ②).

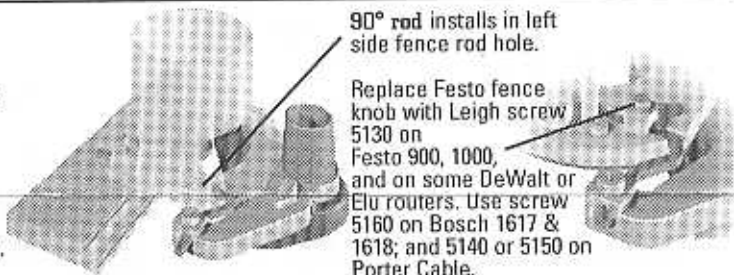

90° rod installs in left side fence rod hole.

Replace Festo fence knob with Leigh screw 5130 on Festo 900, 1000, and on some DeWalt or Elu routers. Use screw 5160 on Bosch 1617 & 1618; and 5140 or 5150 on Porter Cable.

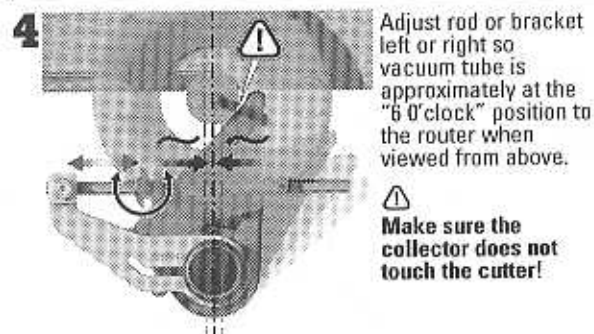

Adjust rod or bracket left or right so vacuum tube is approximately at the "6 o'clock" position to the router when viewed from above.

⚠ Make sure the collector does not touch the cutter!

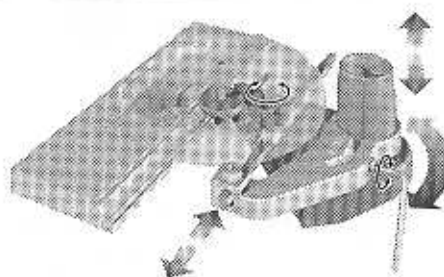

For edge routing, adjust the collector up to almost touch the router base.

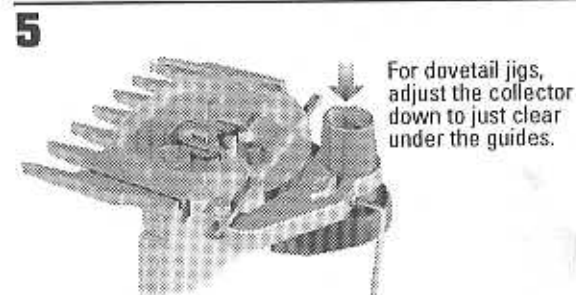

For dovetail jigs, adjust the collector down to just clear under the guides.

LEIGH®

LEIGH INDUSTRIES LTD.

Continued on back

! Carefully read these instructions and your router user guide.

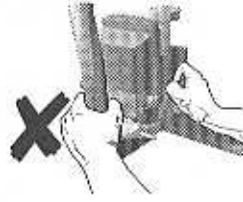

1. Always disconnect the power source when making adjustments.

2. Do not use any part of the RVA1 as a handle.

3. Always suspend the vacuum hose from above.

Do not let the hose hang directly from the RVA1.

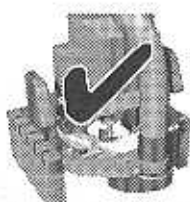
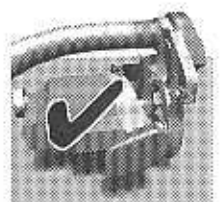

4. Do not stand the router on the RVA1.

5. Either lay it on its side,...

6. ...or make a stand which is cut away for the collector.



If the collector pivot starts to bind, here's how to dismantle, clean, and reassemble your RVA1.

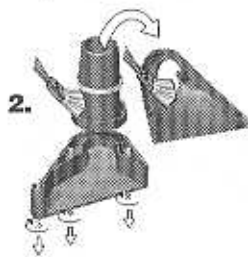
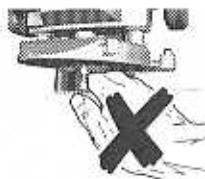

Never reach under the router to clean any blockage.

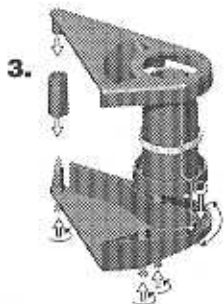

Long slivers may occasionally cause a blockage. Clear this with a short dowel or lath.

Notes:

- The three screws are captive
- Make sure the spring is engaged in both the top housing and tube recesses.
- Don't forget the roller!
- Do not overtighten the screws.



No. Description

- 284 Clamp Nut
- 5000 Top Housing
- 5010 Bottom Housing
- 5020 Tube
- 5030 Roller
- 5040 Hose Adaptor
- 5050 Spring
- 5060 Captive Screws (3)
- 5070 Clamp Bracket (includes part nos. 284, 5080, 5090)
- 5080 Rod Screw 5/16"-18
- 5090 Clamp Screw 1/4"-20
- 5100 Rod
- 5103 Rod Adaptor
- 5110 90° Rod
- 5120 Hex Key 5/32" or 4mm
- 5130 Screw(M6) for Festo & DeWalt
- 5140 Screw(12-24) for Porter Cable
- 5150 Screw(1/4-20) for Porter Cable
- 5160 Screw(M5) for Bosch 1617
- 5170 Instructions

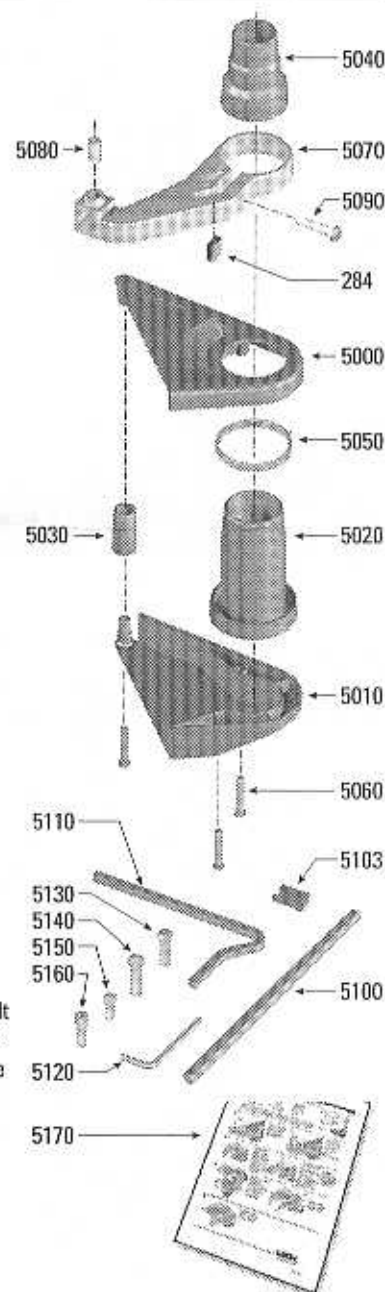

Joining Tradition with Today

LEIGH INDUSTRIES LTD.

PO Box 357, 104 - 1585 Broadway St, Port Coquitlam, BC, Canada V3C 4K6